

A
B
C
D
E
F
G
H
I
J
K
M
N
O
P

SECTION **MIR** MIRRORS

CONTENTS

| | |
|--|---|
| COMPONENT DIAGNOSIS 2 | PREPARATION17 |
| DOOR MIRROR 2 | PREPARATION17 |
| Wiring Diagram2 | Commercial Service Tools17 |
| AUTO ANTI-DAZZLING INSIDE MIRROR SYSTEM 5 | ON-VEHICLE REPAIR 18 |
| Wiring Diagram - Inside Mirror With Homelink Universal Transceiver5 | INSIDE MIRROR 18 |
| Wiring Diagram - Inside Mirror Without Homelink Universal Transceiver8 | Exploded View18 |
| SYMPTOM DIAGNOSIS10 | Removal and Installation18 |
| SQUEAK AND RATTLE TROUBLE DIAGNOSES10 | DOOR MIRROR19 |
| Work Flow10 | Exploded View19 |
| Generic Squeak and Rattle Troubleshooting 12 | Removal and Installation19 |
| Diagnostic Worksheet 14 | DISASSEMBLY AND ASSEMBLY20 |
| PRECAUTION16 | DOOR MIRROR20 |
| PRECAUTIONS16 | Exploded View20 |
| Supplemental Restraint System (SRS) "AIR BAG" and "SEAT BELT PRE-TENSIONER" 16 | Disassembly20 |
| Precautions Necessary for Steering Wheel Rotation after Battery Disconnect 16 | Assembly22 |
| | DOOR MIRROR COVER22 |
| | DOOR MIRROR COVER : Disassembly22 |
| | DOOR MIRROR COVER : Assembly22 |

MIR

DOOR MIRROR

< COMPONENT DIAGNOSIS >

COMPONENT DIAGNOSIS

DOOR MIRROR

Wiring Diagram

INFOID:000000003898795

HM: WITH HEATED MIRRORS
 TM: WITH TURN SIGNAL IN MIRROR

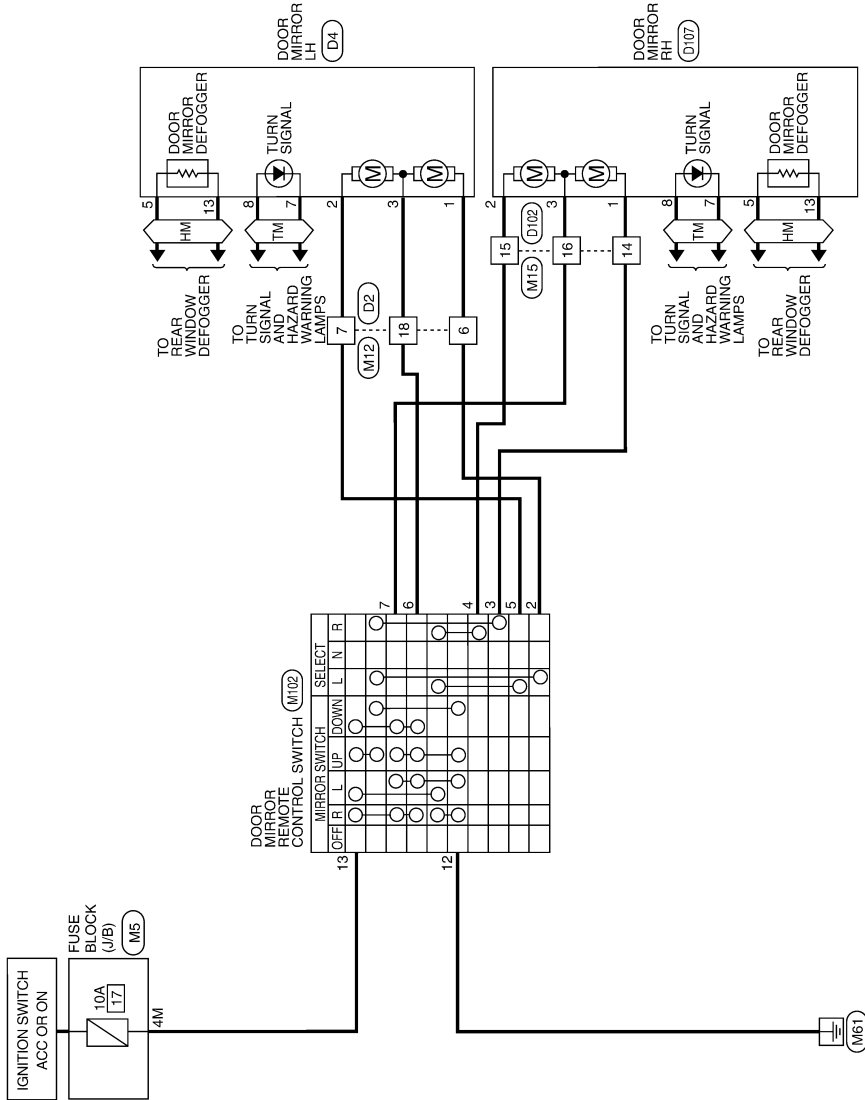

DOOR MIRROR

ABLWA0148GB

DOOR MIRROR

< COMPONENT DIAGNOSIS >

DOOR MIRROR CONNECTORS

| | |
|-----------------|------------------|
| Connector No. | M5 |
| Connector Name | FUSE BLOCK (J/B) |
| Connector Color | WHITE |

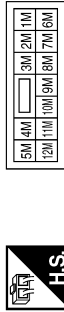

| Terminal No. | Color of Wire | Signal Name |
|--------------|---------------|-------------|
| 4M | V/Y | - |

| | |
|-----------------|--------------|
| Connector No. | M12 |
| Connector Name | WIRE TO WIRE |
| Connector Color | WHITE |

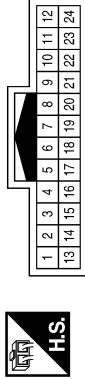

| Terminal No. | Color of Wire | Signal Name |
|--------------|---------------|-------------|
| 6 | GR | - |
| 7 | V | - |
| 18 | Y | - |

| | |
|-----------------|--------------|
| Connector No. | M15 |
| Connector Name | WIRE TO WIRE |
| Connector Color | WHITE |

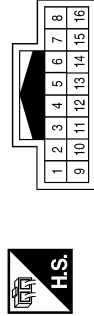

| Terminal No. | Color of Wire | Signal Name |
|--------------|---------------|-------------|
| 14 | G | - |
| 15 | V | - |
| 16 | Y | - |

| | |
|-----------------|--|
| Connector No. | M102 |
| Connector Name | DOOR MIRROR REMOTE CONTROL SWITCH (WITHOUT AUTOMATIC DRIVE POSITIONER) |
| Connector Color | WHITE |

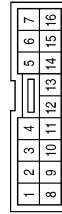

| Terminal No. | Color of Wire | Signal Name |
|--------------|---------------|---------------|
| 2 | GR | LH LEFT |
| 3 | G | RH UP |
| 4 | V | RH LEFT |
| 5 | V | LH RIGHT/DOWN |
| 6 | Y | LH UP |
| 7 | Y | RH RIGHT/DOWN |
| 12 | B | GND |
| 13 | V/Y | IGN |

| | |
|-----------------|--------------|
| Connector No. | D2 |
| Connector Name | WIRE TO WIRE |
| Connector Color | WHITE |

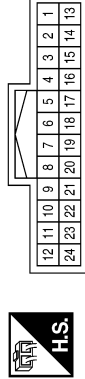

| Terminal No. | Color of Wire | Signal Name |
|--------------|---------------|-------------|
| 6 | V | - |
| 7 | P | - |
| 18 | LG | - |

| | |
|-----------------|----------------|
| Connector No. | D4 |
| Connector Name | DOOR MIRROR LH |
| Connector Color | WHITE |

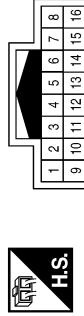

| Terminal No. | Color of Wire | Signal Name |
|--------------|---------------|-------------|
| 1 | V | UP |
| 2 | P | LEFT |
| 3 | LG | RIGHT/DOWN |
| 5 | O | HEATER(+) |
| 7 | B | TURN(-) |
| 8 | GR | TURN(+) |
| 13 | B | HEATER GND |

ABLIA0532GB

DOOR MIRROR

< COMPONENT DIAGNOSIS >

| | |
|-----------------|----------------|
| Connector No. | D107 |
| Connector Name | DOOR MIRROR RH |
| Connector Color | WHITE |

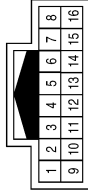

| Terminal No. | Color of Wire | Signal Name |
|--------------|---------------|-------------|
| 1 | V | UP |
| 2 | P | LEFT |
| 3 | LG | RIGHT/DOWN |
| 5 | O | HEATER(+) |
| 7 | B | TURN(-) |
| 8 | W | TURN(+) |
| 13 | B | HEATER GND |

| | |
|-----------------|--------------|
| Connector No. | D102 |
| Connector Name | WIRE TO WIRE |
| Connector Color | WHITE |

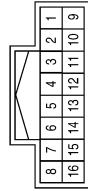

| Terminal No. | Color of Wire | Signal Name |
|--------------|---------------|-------------|
| 14 | V | - |
| 15 | P | - |
| 16 | LG | - |

ABLIA0533GB

AUTO ANTI-DAZZLING INSIDE MIRROR SYSTEM

< COMPONENT DIAGNOSIS >

AUTO ANTI-DAZZLING INSIDE MIRROR SYSTEM

Wiring Diagram - Inside Mirror With Homelink Universal Transceiver

INFOID:000000004221441

INSIDE MIRROR - WITH HOMELINK UNIVERSAL TRANSCEIVER

EC : WITH AUTO DIMMING OUTSIDE MIRRORS

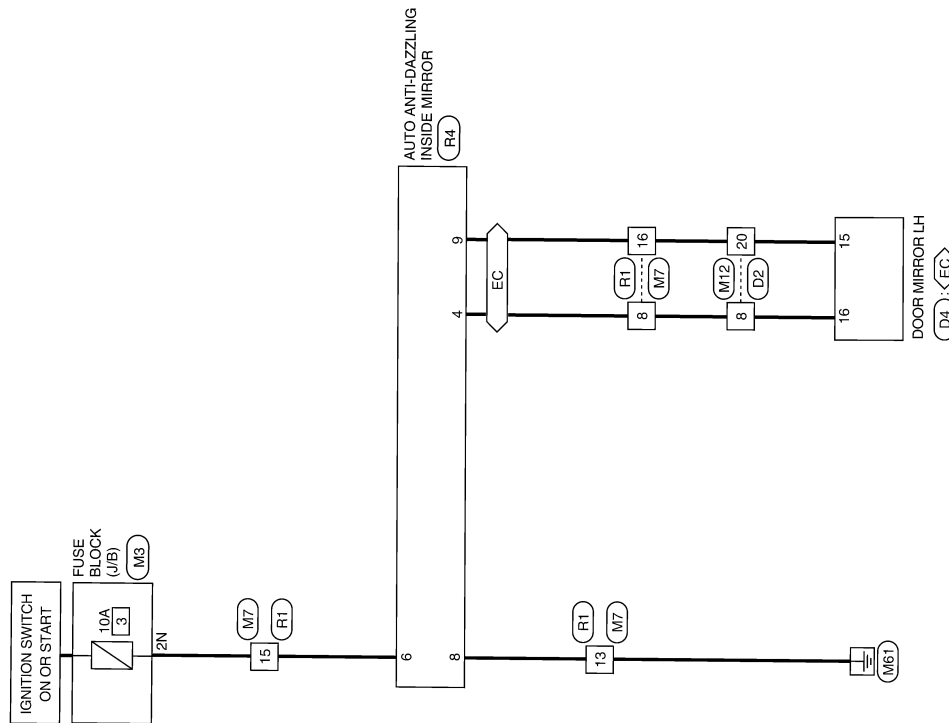

A
B
C
D
E
F
G
H
I
J
K
L
M
N
O
P

MIR

ABLWA0149GB

AUTO ANTI-DAZZLING INSIDE MIRROR SYSTEM

< COMPONENT DIAGNOSIS >

INSIDE MIRROR CONNECTORS - WITH HOMELINK UNIVERSAL TRANSCEIVER

| | |
|-----------------|------------------|
| Connector No. | M3 |
| Connector Name | FUSE BLOCK (J/B) |
| Connector Color | WHITE |

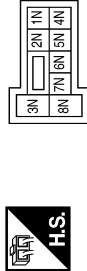

| Terminal No. | Color of Wire | Signal Name |
|--------------|---------------|-------------|
| 2N | G | - |

| | |
|-----------------|--------------|
| Connector No. | M7 |
| Connector Name | WIRE TO WIRE |
| Connector Color | WHITE |

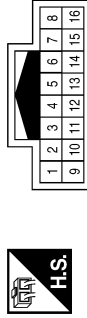

| Terminal No. | Color of Wire | Signal Name |
|--------------|---------------|-------------|
| 8 | L | - |
| 13 | B | - |
| 15 | G | - |
| 16 | SB | - |

| | |
|-----------------|--------------|
| Connector No. | M12 |
| Connector Name | WIRE TO WIRE |
| Connector Color | WHITE |

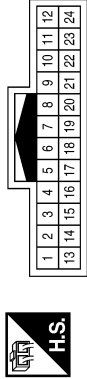

| Terminal No. | Color of Wire | Signal Name |
|--------------|---------------|-------------|
| 8 | L | - |
| 20 | SB | - |

| | |
|-----------------|--------------|
| Connector No. | R1 |
| Connector Name | WIRE TO WIRE |
| Connector Color | WHITE |

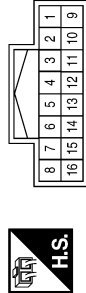

| Terminal No. | Color of Wire | Signal Name |
|--------------|---------------|-------------|
| 8 | B/W | - |
| 13 | B | - |
| 15 | B/R | - |
| 16 | B/O | - |

| | |
|-----------------|--|
| Connector No. | R4 |
| Connector Name | AUTO ANTI-DAZZLING INSIDE MIRROR (WITH HOMELINK UNIVERSAL TRANSCEIVER) |
| Connector Color | BLACK |

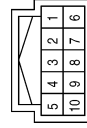

| Terminal No. | Color of Wire | Signal Name |
|--------------|---------------|-------------|
| 4 | B/W | OEC+ |
| 6 | B/R | IGN |
| 8 | B | GND |
| 9 | B/O | OEC- |

| | |
|-----------------|--------------|
| Connector No. | D2 |
| Connector Name | WIRE TO WIRE |
| Connector Color | WHITE |

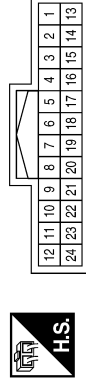

| Terminal No. | Color of Wire | Signal Name |
|--------------|---------------|-------------|
| 8 | SB | - |
| 20 | L | - |

AUTO ANTI-DAZZLING INSIDE MIRROR SYSTEM

< COMPONENT DIAGNOSIS >

A
B
C
D
E
F
G
H
I
J
K
M
N
O
P

| | |
|-----------------|----------------|
| Connector No. | D4 |
| Connector Name | DOOR MIRROR LH |
| Connector Color | WHITE |

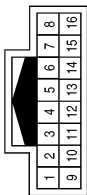

| Terminal No. | Color of Wire | Signal Name |
|--------------|---------------|-------------|
| 15 | L | EC- |
| 16 | SB | EC+ |

MIR

ABLIA0535GB

AUTO ANTI-DAZZLING INSIDE MIRROR SYSTEM

< COMPONENT DIAGNOSIS >

Wiring Diagram - Inside Mirror Without Homelink Universal Transceiver

INFOID:000000003898796

INSIDE MIRROR - WITHOUT HOMELINK UNIVERSAL TRANSCEIVER

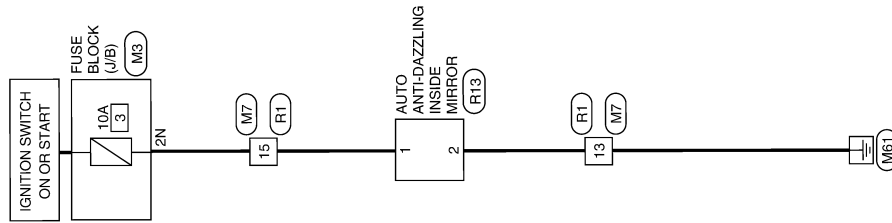

ABLWA0150GB

AUTO ANTI-DAZZLING INSIDE MIRROR SYSTEM

< COMPONENT DIAGNOSIS >

INSIDE MIRROR CONNECTORS - WITHOUT HOMELINK UNIVERSAL TRANSCEIVER

| | |
|-----------------|------------------|
| Connector No. | M3 |
| Connector Name | FUSE BLOCK (J/B) |
| Connector Color | WHITE |

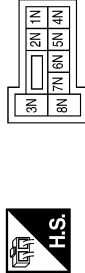

| | | | | | |
|--------------|----|---------------|---|-------------|---|
| Terminal No. | 2N | Color of Wire | G | Signal Name | - |
|--------------|----|---------------|---|-------------|---|

| | |
|-----------------|--------------|
| Connector No. | M7 |
| Connector Name | WIRE TO WIRE |
| Connector Color | WHITE |

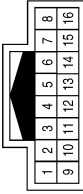

| | | | | | |
|--------------|----|---------------|---|-------------|---|
| Terminal No. | 13 | Color of Wire | B | Signal Name | - |
| Terminal No. | 15 | Color of Wire | G | Signal Name | - |

| | |
|-----------------|--------------|
| Connector No. | R1 |
| Connector Name | WIRE TO WIRE |
| Connector Color | WHITE |

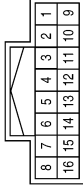

| | | | | | |
|--------------|----|---------------|-----|-------------|---|
| Terminal No. | 13 | Color of Wire | B | Signal Name | - |
| Terminal No. | 15 | Color of Wire | B/R | Signal Name | - |

| | |
|-----------------|---|
| Connector No. | R13 |
| Connector Name | AUTO ANTI - DAZZLING INSIDE MIRROR (WITHOUT HOMELINK UNIVERSAL TRANSCEIVER) |
| Connector Color | BLACK |

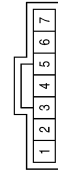

| | | | | | |
|--------------|---|---------------|-----|-------------|-----|
| Terminal No. | 1 | Color of Wire | B/R | Signal Name | IGN |
| Terminal No. | 2 | Color of Wire | B | Signal Name | GND |

A
B
C
D
E
F
G
H
I
J
K
M
N
O
P

MIR

SQUEAK AND RATTLE TROUBLE DIAGNOSES

< SYMPTOM DIAGNOSIS >

SYMPTOM DIAGNOSIS

SQUEAK AND RATTLE TROUBLE DIAGNOSES

Work Flow

INFOID:000000003898797

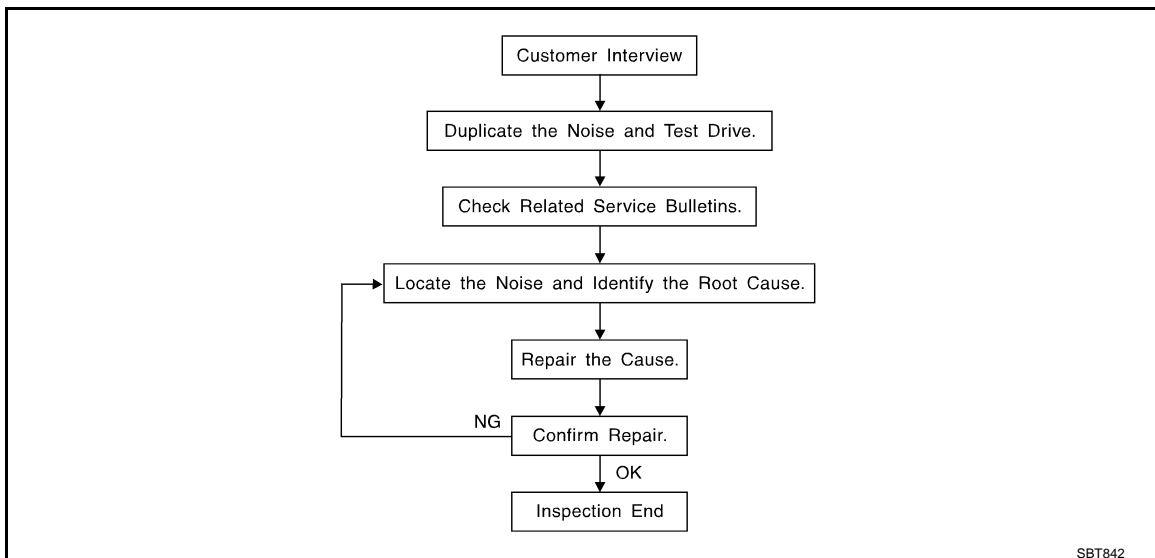

CUSTOMER INTERVIEW

Interview the customer if possible, to determine the conditions that exist when the noise occurs. Use the Diagnostic Worksheet during the interview to document the facts and conditions when the noise occurs and any customer's comments; refer to [MIR-14. "Diagnostic Worksheet"](#). This information is necessary to duplicate the conditions that exist when the noise occurs.

- The customer may not be able to provide a detailed description or the location of the noise. Attempt to obtain all the facts and conditions that exist when the noise occurs (or does not occur).
- If there is more than one noise in the vehicle, be sure to diagnose and repair the noise that the customer is concerned about. This can be accomplished by test driving the vehicle with the customer.
- After identifying the type of noise, isolate the noise in terms of its characteristics. The noise characteristics are provided so the customer, service adviser and technician are all speaking the same language when defining the noise.
- Squeak —(Like tennis shoes on a clean floor)
Squeak characteristics include the light contact/fast movement/brought on by road conditions/hard surfaces=higher pitch noise/softer surfaces=lowerpitch noises/edge to surface=chirping
- Creak—(Like walking on an old wooden floor)
Creak characteristics include firm contact/slow movement/twisting with a rotational movement/pitch dependent on materials/often brought on by activity.
- Rattle—(Like shaking a baby rattle)
Rattle characteristics include the fast repeated contact/vibration or similar movement/loose parts/missing clip or fastener/incorrect clearance.
- Knock —(Like a knock on a door)
Knock characteristics include hollow sounding/sometimes repeating/often brought on by driver action.
- Tick—(Like a clock second hand)
Tick characteristics include gentle contacting of light materials/loose components/can be caused by driver action or road conditions.
- Thump—(Heavy, muffled knock noise)
Thump characteristics include softer knock/dead sound often brought on by activity.
- Buzz—(Like a bumble bee)
Buzz characteristics include high frequency rattle/firm contact.
- Often the degree of acceptable noise level will vary depending upon the person. A noise that you may judge as acceptable may be very irritating to the customer.
- Weather conditions, especially humidity and temperature, may have a great effect on noise level.

DUPLICATE THE NOISE AND TEST DRIVE

SQUEAK AND RATTLE TROUBLE DIAGNOSES

< SYMPTOM DIAGNOSIS >

If possible, drive the vehicle with the customer until the noise is duplicated. Note any additional information on the Diagnostic Worksheet regarding the conditions or location of the noise. This information can be used to duplicate the same conditions when you confirm the repair.

If the noise can be duplicated easily during the test drive, to help identify the source of the noise, try to duplicate the noise with the vehicle stopped by doing one or all of the following:

- 1) Close a door.
 - 2) Tap or push/pull around the area where the noise appears to be coming from.
 - 3) Rev the engine.
 - 4) Use a floor jack to recreate vehicle "twist".
 - 5) At idle, apply engine load (electrical load, half-clutch on M/T models, drive position on CVT models).
 - 6) Raise the vehicle on a hoist and hit a tire with a rubber hammer.
- Drive the vehicle and attempt to duplicate the conditions the customer states exist when the noise occurs.
 - If it is difficult to duplicate the noise, drive the vehicle slowly on an undulating or rough road to stress the vehicle body.

CHECK RELATED SERVICE BULLETINS

After verifying the customer concern or symptom, check ASIST for Technical Service Bulletins (TSBs) related to that concern or symptom.

If a TSB relates to the symptom, follow the procedure to repair the noise.

LOCATE THE NOISE AND IDENTIFY THE ROOT CAUSE

1. Narrow down the noise to a general area. To help pinpoint the source of the noise, use a listening tool (Chassis Ear: J-39570, Engine Ear and mechanics stethoscope).
2. Narrow down the noise to a more specific area and identify the cause of the noise by:
 - removing the components in the area that you suspect the noise is coming from.
Do not use too much force when removing clips and fasteners, otherwise clips and fastener can be broken or lost during the repair, resulting in the creation of new noise.
 - tapping or pushing/pulling the component that you suspect is causing the noise.
Do not tap or push/pull the component with excessive force, otherwise the noise will be eliminated only temporarily.
 - feeling for a vibration with your hand by touching the component(s) that you suspect is (are) causing the noise.
 - placing a piece of paper between components that you suspect are causing the noise.
 - looking for loose components and contact marks.
Refer to [MIR-12. "Generic Squeak and Rattle Troubleshooting"](#).

REPAIR THE CAUSE

- If the cause is a loose component, tighten the component securely.
- If the cause is insufficient clearance between components:
 - separate components by repositioning or loosening and retightening the component, if possible.
 - insulate components with a suitable insulator such as urethane pads, foam blocks, felt cloth tape or urethane tape. A Nissan Squeak and Rattle Kit (J-43980) is available through your authorized Nissan Parts Department.

CAUTION:

Do not use excessive force as many components are constructed of plastic and may be damaged.

NOTE:

Always check with the Parts Department for the latest parts information.

The following materials are contained in the Nissan Squeak and Rattle Kit (J-43980). Each item can be ordered separately as needed.

URETHANE PADS [1.5 mm (0.059 in) thick]

Insulates connectors, harness, etc.

76268-9E005: 100 × 135 mm (3.94 × 5.31 in)/76884-71L01: 60 × 85 mm (2.36 × 3.35 in)/76884-71L02: 15 × 25 mm (0.59 × 0.98 in)

INSULATOR (Foam blocks)

Insulates components from contact. Can be used to fill space behind a panel.

73982-9E000: 45 mm (1.77 in) thick, 50 × 50 mm (1.97 × 1.97 in)/73982-

50Y00: 10 mm (0.39 in) thick, 50 × 50 mm (1.97 × 1.97 in)

INSULATOR (Light foam block)

80845-71L00: 30 mm (1.18 in) thick, 30 × 50 mm (1.18 × 1.97 in)

FELT CLOTHTAPE

Used to insulate where movement does not occur. Ideal for instrument panel applications.

SQUEAK AND RATTLE TROUBLE DIAGNOSES

< SYMPTOM DIAGNOSIS >

68370-4B000: 15 × 25 mm (0.59 × 0.98 in) pad/68239-13E00: 5 mm (0.20 in) wide tape roll

The following materials, not found in the kit, can also be used to repair squeaks and rattles.

UHMW (TEFLON) TAPE

Insulates where slight movement is present. Ideal for instrument panel applications.

SILICONE GREASE

Used in place of UHMW tape that will be visible or not fit. Will only last a few months.

SILICONE SPRAY

Use when grease cannot be applied.

DUCT TAPE

Use to eliminate movement.

CONFIRM THE REPAIR

Confirm that the cause of a noise is repaired by test driving the vehicle. Operate the vehicle under the same conditions as when the noise originally occurred. Refer to the notes on the Diagnostic Worksheet.

Generic Squeak and Rattle Troubleshooting

INFOID:000000003898798

Refer to Table of Contents for specific component removal and installation information.

INSTRUMENT PANEL

Most incidents are caused by contact and movement between:

1. The cluster lid A and instrument panel
2. Acrylic lens and combination meter housing
3. Instrument panel to front pillar garnish
4. Instrument panel to windshield
5. Instrument panel mounting pins
6. Wiring harnesses behind the combination meter
7. A/C defroster duct and duct joint

These incidents can usually be located by tapping or moving the components to duplicate the noise or by pressing on the components while driving to stop the noise. Most of these incidents can be repaired by applying felt cloth tape or silicon spray (in hard to reach areas). Urethane pads can be used to insulate wiring harness.

CAUTION:

Do not use silicone spray to isolate a squeak or rattle. If you saturate the area with silicone, you will not be able to recheck the repair.

CENTER CONSOLE

Components to pay attention to include:

1. Shifter assembly cover to finisher
2. A/C control unit and cluster lid C
3. Wiring harnesses behind audio and A/C control unit

The instrument panel repair and isolation procedures also apply to the center console.

DOORS

Pay attention to the:

1. Finisher and inner panel making a slapping noise
2. Inside handle escutcheon to door finisher
3. Wiring harnesses tapping
4. Door striker out of alignment causing a popping noise on starts and stops

Tapping or moving the components or pressing on them while driving to duplicate the conditions can isolate many of these incidents. You can usually insulate the areas with felt cloth tape or insulator foam blocks from the Nissan Squeak and Rattle Kit (J-43980) to repair the noise.

TRUNK

Trunk noises are often caused by a loose jack or loose items put into the trunk by the owner.

In addition look for:

1. Trunk lid dumpers out of adjustment
2. Trunk lid striker out of adjustment

SQUEAK AND RATTLE TROUBLE DIAGNOSES

< SYMPTOM DIAGNOSIS >

3. The trunk lid torsion bars knocking together
4. A loose license plate or bracket

Most of these incidents can be repaired by adjusting, securing or insulating the item(s) or component(s) causing the noise.

SUNROOF/HEADLINING

Noises in the sunroof/headlining area can often be traced to one of the following:

1. Sunroof lid, rail, linkage or seals making a rattle or light knocking noise
2. Sunvisor shaft shaking in the holder
3. Front or rear windshield touching headlining and squeaking

Again, pressing on the components to stop the noise while duplicating the conditions can isolate most of these incidents. Repairs usually consist of insulating with felt cloth tape.

SEATS

When isolating seat noise it's important to note the position the seat is in and the load placed on the seat when the noise is present. These conditions should be duplicated when verifying and isolating the cause of the noise.

Cause of seat noise include:

1. Headrest rods and holder
2. A squeak between the seat pad cushion and frame
3. The rear seatback lock and bracket

These noises can be isolated by moving or pressing on the suspected components while duplicating the conditions under which the noise occurs. Most of these incidents can be repaired by repositioning the component or applying urethane tape to the contact area.

UNDERHOOD

Some interior noise may be caused by components under the hood or on the engine wall. The noise is then transmitted into the passenger compartment.

Causes of transmitted underhood noise include:

1. Any component mounted to the engine wall
2. Components that pass through the engine wall
3. Engine wall mounts and connectors
4. Loose radiator mounting pins
5. Hood bumpers out of adjustment
6. Hood striker out of adjustment

These noises can be difficult to isolate since they cannot be reached from the interior of the vehicle. The best method is to secure, move or insulate one component at a time and test drive the vehicle. Also, engine RPM or load can be changed to isolate the noise. Repairs can usually be made by moving, adjusting, securing, or insulating the component causing the noise.

A
B
C
D
E
F
G
H
I
J
K
M
N
O
P

MIR

SQUEAK AND RATTLE TROUBLE DIAGNOSES

< SYMPTOM DIAGNOSIS >

Diagnostic Worksheet

INFOID:000000003898799

Dear Customer:

We are concerned about your satisfaction with your vehicle. Repairing a squeak or rattle sometimes can be very difficult. To help us fix your vehicle right the first time, please take a moment to note the area of the vehicle where the squeak or rattle occurs and under what conditions. You may be asked to take a test drive with a service advisor or technician to ensure we confirm the noise you are hearing.

SQUEAK & RATTLE DIAGNOSTIC WORKSHEET

I. WHERE DOES THE NOISE COME FROM? (circle the area of the vehicle)

The illustrations are for reference only, and may not reflect the actual configuration of your vehicle.

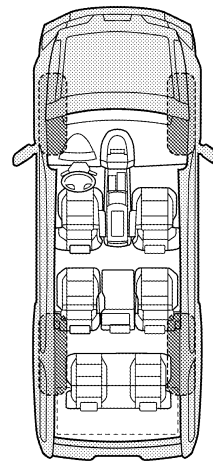

Continue to page 2 of the worksheet and briefly describe the location of the noise or rattle. In addition, please indicate the conditions which are present when the noise occurs.

SQUEAK AND RATTLE TROUBLE DIAGNOSES

< SYMPTOM DIAGNOSIS >

SQUEAK & RATTLE DIAGNOSTIC WORKSHEET - page 2

Briefly describe the location where the noise occurs:

II. WHEN DOES IT OCCUR? (please check the boxes that apply)

- | | |
|---|--|
| <input type="checkbox"/> Anytime | <input type="checkbox"/> After sitting out in the rain |
| <input type="checkbox"/> 1st time in the morning | <input type="checkbox"/> When it is raining or wet |
| <input type="checkbox"/> Only when it is cold outside | <input type="checkbox"/> Dry or dusty conditions |
| <input type="checkbox"/> Only when it is hot outside | <input type="checkbox"/> Other: |

III. WHEN DRIVING:

- Through driveways
- Over rough roads
- Over speed bumps
- Only about ____ mph
- On acceleration
- Coming to a stop
- On turns: left, right or either (circle)
- With passengers or cargo
- Other: _____
- After driving ____ miles or ____ minutes

IV. WHAT TYPE OF NOISE

- Squeak (like tennis shoes on a clean floor)
- Creak (like walking on an old wooden floor)
- Rattle (like shaking a baby rattle)
- Knock (like a knock at the door)
- Tick (like a clock second hand)
- Thump (heavy muffled knock noise)
- Buzz (like a bumble bee)

TO BE COMPLETED BY DEALERSHIP PERSONNEL

Test Drive Notes:

| | YES | NO | Initials of person performing |
|--|--------------------------|--------------------------|-------------------------------|
| Vehicle test driven with customer | <input type="checkbox"/> | <input type="checkbox"/> | _____ |
| - Noise verified on test drive | <input type="checkbox"/> | <input type="checkbox"/> | _____ |
| - Noise source located and repaired | <input type="checkbox"/> | <input type="checkbox"/> | _____ |
| - Follow up test drive performed to confirm repair | <input type="checkbox"/> | <input type="checkbox"/> | _____ |

VIN: _____ Customer Name _____

W.O.# _____ Date: _____

This form must be attached to Work Order

LAI0071E

A
B
C
D
E
F
G
H
I
J
K
M
N
O
P

MIR

PRECAUTIONS

< PRECAUTION >

PRECAUTION

PRECAUTIONS

Supplemental Restraint System (SRS) "AIR BAG" and "SEAT BELT PRE-TENSIONER"

INFOID:000000003898800

The Supplemental Restraint System such as "AIR BAG" and "SEAT BELT PRE-TENSIONER", used along with a front seat belt, helps to reduce the risk or severity of injury to the driver and front passenger for certain types of collision. This system includes seat belt switch inputs and dual stage front air bag modules. The SRS system uses the seat belt switches to determine the front air bag deployment, and may only deploy one front air bag, depending on the severity of a collision and whether the front occupants are belted or unbelted. Information necessary to service the system safely is included in the SR and SB section of this Service Manual.

WARNING:

- To avoid rendering the SRS inoperative, which could increase the risk of personal injury or death in the event of a collision which would result in air bag inflation, all maintenance must be performed by an authorized NISSAN/INFINITI dealer.
- Improper maintenance, including incorrect removal and installation of the SRS, can lead to personal injury caused by unintentional activation of the system. For removal of Spiral Cable and Air Bag Module, see the SR section.
- Do not use electrical test equipment on any circuit related to the SRS unless instructed to in this Service Manual. SRS wiring harnesses can be identified by yellow and/or orange harnesses or harness connectors.

Precautions Necessary for Steering Wheel Rotation after Battery Disconnect

INFOID:000000004394040

NOTE:

- Before removing and installing any control units, first turn the push-button ignition switch to the LOCK position, then disconnect both battery cables.
- After finishing work, confirm that all control unit connectors are connected properly, then re-connect both battery cables.
- Always use CONSULT-III to perform self-diagnosis as a part of each function inspection after finishing work. If a DTC is detected, perform trouble diagnosis according to self-diagnosis results.

This vehicle is equipped with a push-button ignition switch and a steering lock unit.

If the battery is disconnected or discharged, the steering wheel will lock and cannot be turned.

If turning the steering wheel is required with the battery disconnected or discharged, follow the procedure below before starting the repair operation.

OPERATION PROCEDURE

1. Connect both battery cables.

NOTE:

Supply power using jumper cables if battery is discharged.

2. Carry the Intelligent Key or insert it to the key slot and turn the push-button ignition switch to ACC position. (At this time, the steering lock will be released.)
3. Disconnect both battery cables. The steering lock will remain released with both battery cables disconnected and the steering wheel can be turned.
4. Perform the necessary repair operation.
5. When the repair work is completed, re-connect both battery cables. With the brake pedal released, turn the push-button ignition switch from ACC position to ON position, then to LOCK position. (The steering wheel will lock when the push-button ignition switch is turned to LOCK position.)
6. Perform self-diagnosis check of all control units using CONSULT-III.

PREPARATION

< PREPARATION >

PREPARATION

PREPARATION

Commercial Service Tools

INFOID:000000003898801

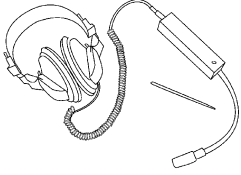
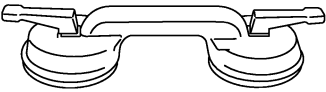
| Tool name | Description |
|--|---|
| <p data-bbox="191 516 305 543">Engine ear</p>  <p data-bbox="803 632 868 646">SIA0995E</p> | <p data-bbox="1003 516 1187 543">Locating the noise</p> |
| <p data-bbox="191 768 321 795">Suction lifter</p>  <p data-bbox="803 884 868 898">PIIB1805J</p> | <p data-bbox="1003 768 1230 795">Holding the door glass</p> |

A
B
C
D
E
F
G
H
I
J
K
M
N
O
P

MIR

INSIDE MIRROR

< ON-VEHICLE REPAIR >

ON-VEHICLE REPAIR

INSIDE MIRROR

Exploded View

INFOID:000000003898802

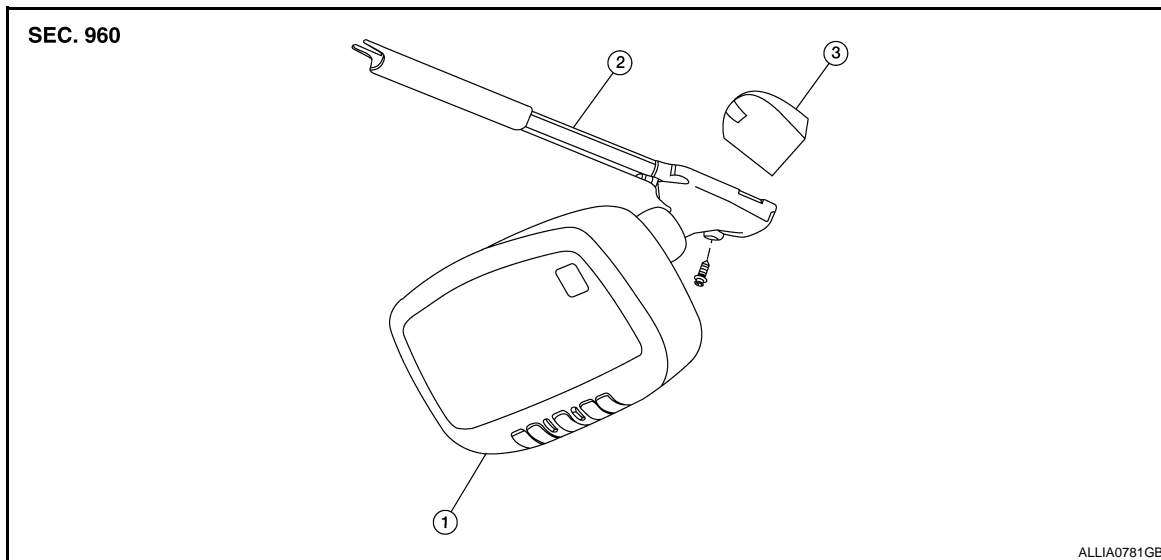

1. Inside mirror

2. Inside mirror finisher

3. Mirror base

Removal and Installation

INFOID:000000003898803

REMOVAL

1. Remove inside mirror finisher.
2. Remove screw of mirror base.
3. Slide the mirror upward to remove.
4. Disconnect the connector.

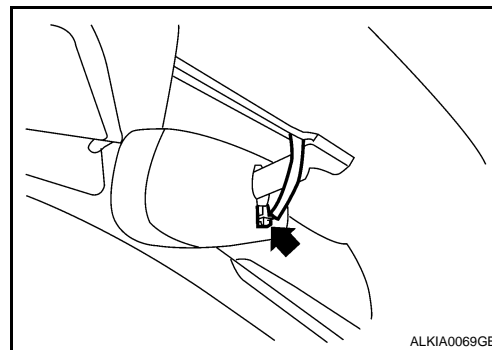

INSTALLATION

Installation is in the reverse order of removal.

CAUTION:

Apply Genuine Mirror Adhesive or equivalent to bonding surface of mounting bracket. Refer to [GL-15](#), "[Recommended Chemical Products and Sealants](#)".

DOOR MIRROR

< ON-VEHICLE REPAIR >

DOOR MIRROR

Exploded View

INFOID:000000003898804

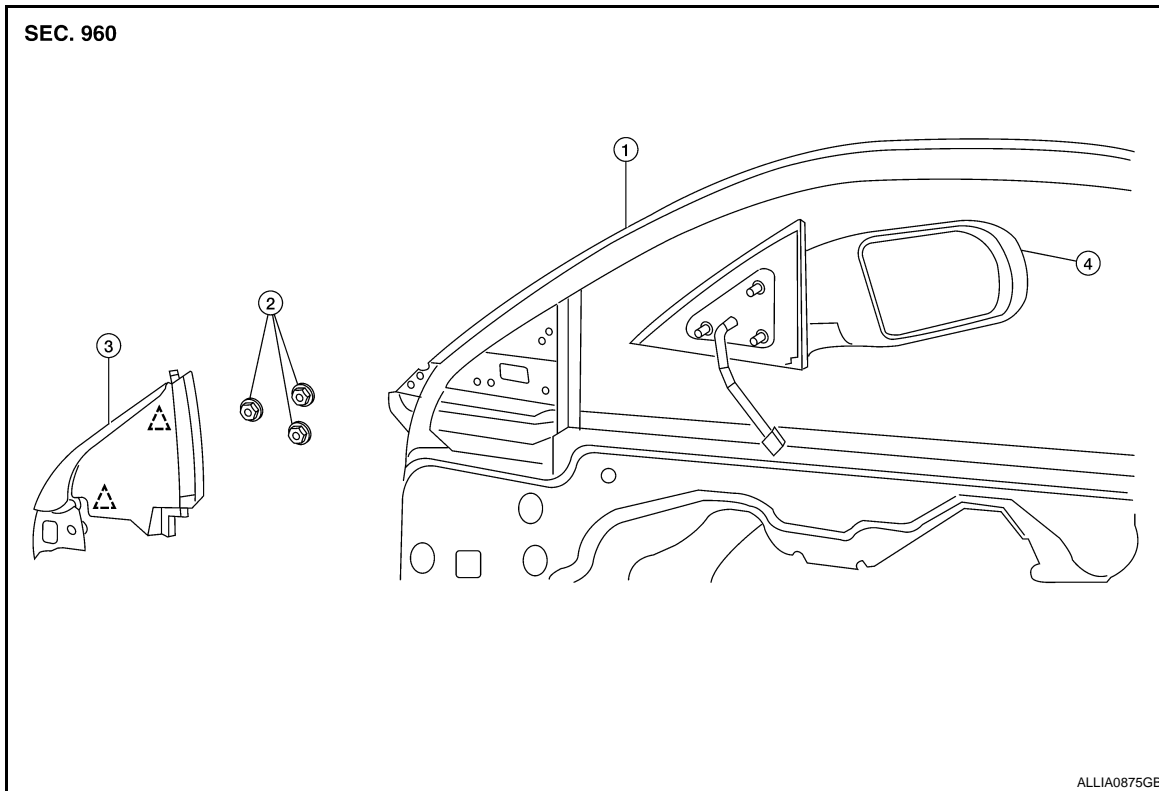

- 1. Door panel
 - 2. Nuts
 - 3. Corner cover
 - 4. Mirror assembly
- △ Clip C101

Removal and Installation

INFOID:000000003898805

REMOVAL

1. Remove the front door finisher. Refer to [INT-18, "Removal and Installation"](#).
2. Remove the corner cover.
3. Disconnect the door mirror harness connector.
4. Remove the door mirror mounting nuts, and remove the door mirror assembly.

INSTALLATION

Installation is in the reverse order of removal.

A
B
C
D
E
F
G
H
I
J
K
M
N
O
P

MIR

DOOR MIRROR

< DISASSEMBLY AND ASSEMBLY >

DISASSEMBLY AND ASSEMBLY

DOOR MIRROR

Exploded View

INFOID:000000003898806

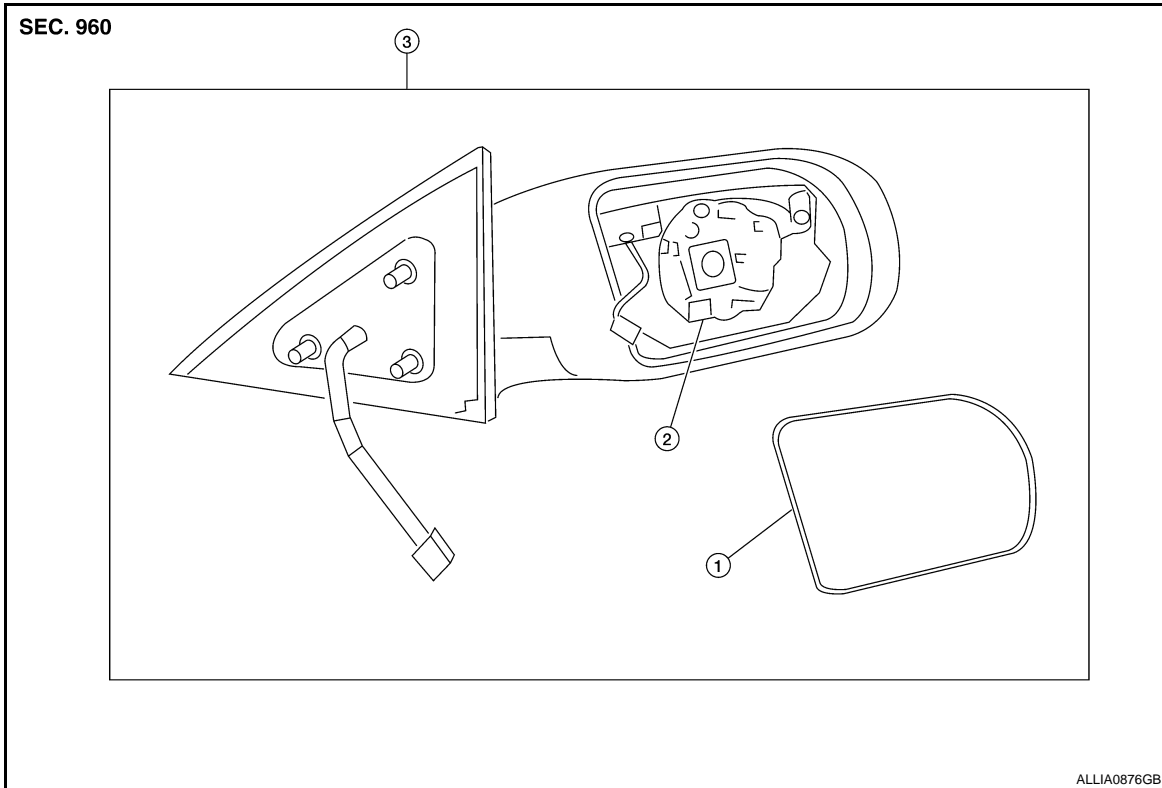

1. Mirror glass

2. Actuator assembly

3. Mirror assembly

Disassembly

INFOID:000000003898807

1. Turn the mirror glass surface upward.
2. Pull from the bottom to disengage lower clips.

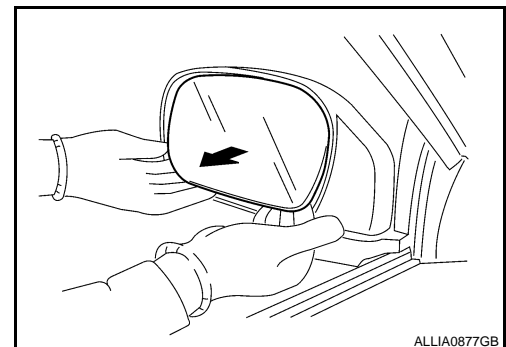

DOOR MIRROR

< DISASSEMBLY AND ASSEMBLY >

3. Lift to disengage the upper mirror hooks (A).

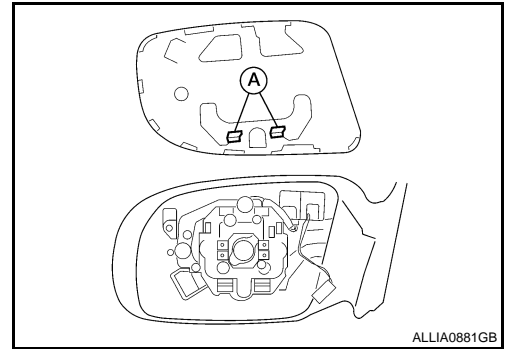

4. Disconnect the mirror connector.
5. Remove the mirror body (1) from the mirror housing assembly (2).

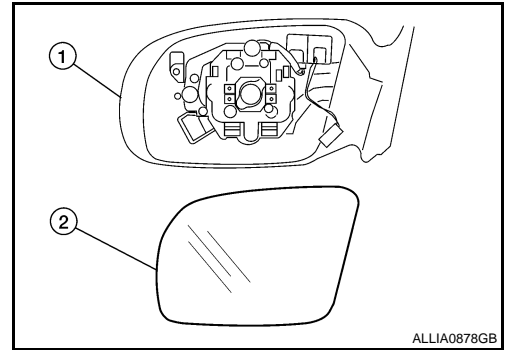

6. Remove the actuator screws.

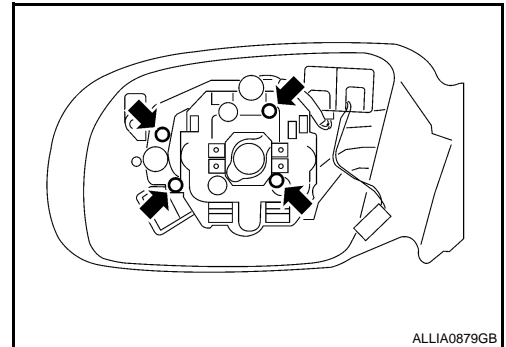

7. Disconnect the mirror connector (A) and remove actuator assembly.

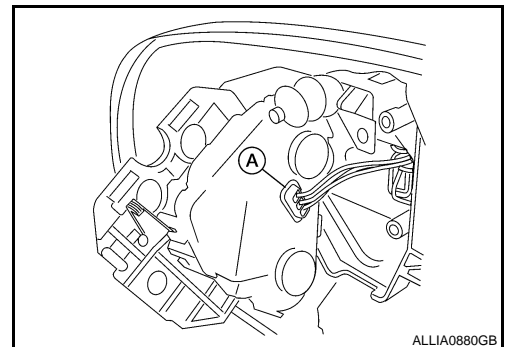

A
B
C
D
E
F
G
H
I
J
K
M
N
O
P

MIR

DOOR MIRROR

< DISASSEMBLY AND ASSEMBLY >

8. Disengage the pawls and remove the mirror cover from the mirror assembly.



Pawl

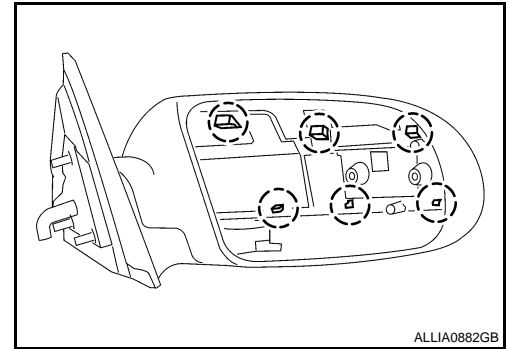

ALLIA0882GB

INFOID:00000000389808

Assembly

Installation is in the reverse order of removal.

DOOR MIRROR COVER

DOOR MIRROR COVER : Disassembly

INFOID:000000004237157

1. Using a suitable tool disengage the upper mirror cover pawls.



Pawl

2. Using a suitable tool disengage the lower mirror cover pawls and remove mirror cover.

CAUTION:

Be careful not to damage the mirror or mirror cover with tool.

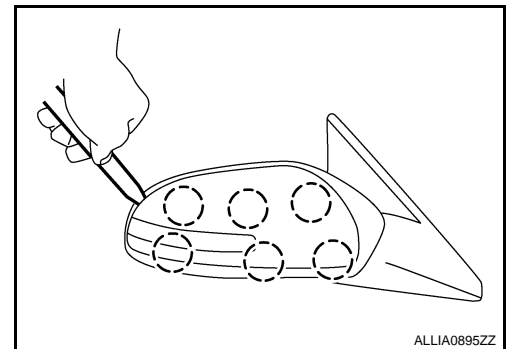

ALLIA0895ZZ

INFOID:000000004237158

DOOR MIRROR COVER : Assembly

Installation is in the reverse order of removal.

CAUTION:

After installation, check that pawls are securely engaged.